

VILLA SIV, SITUATIONSPLAN  
SKALA 1:300

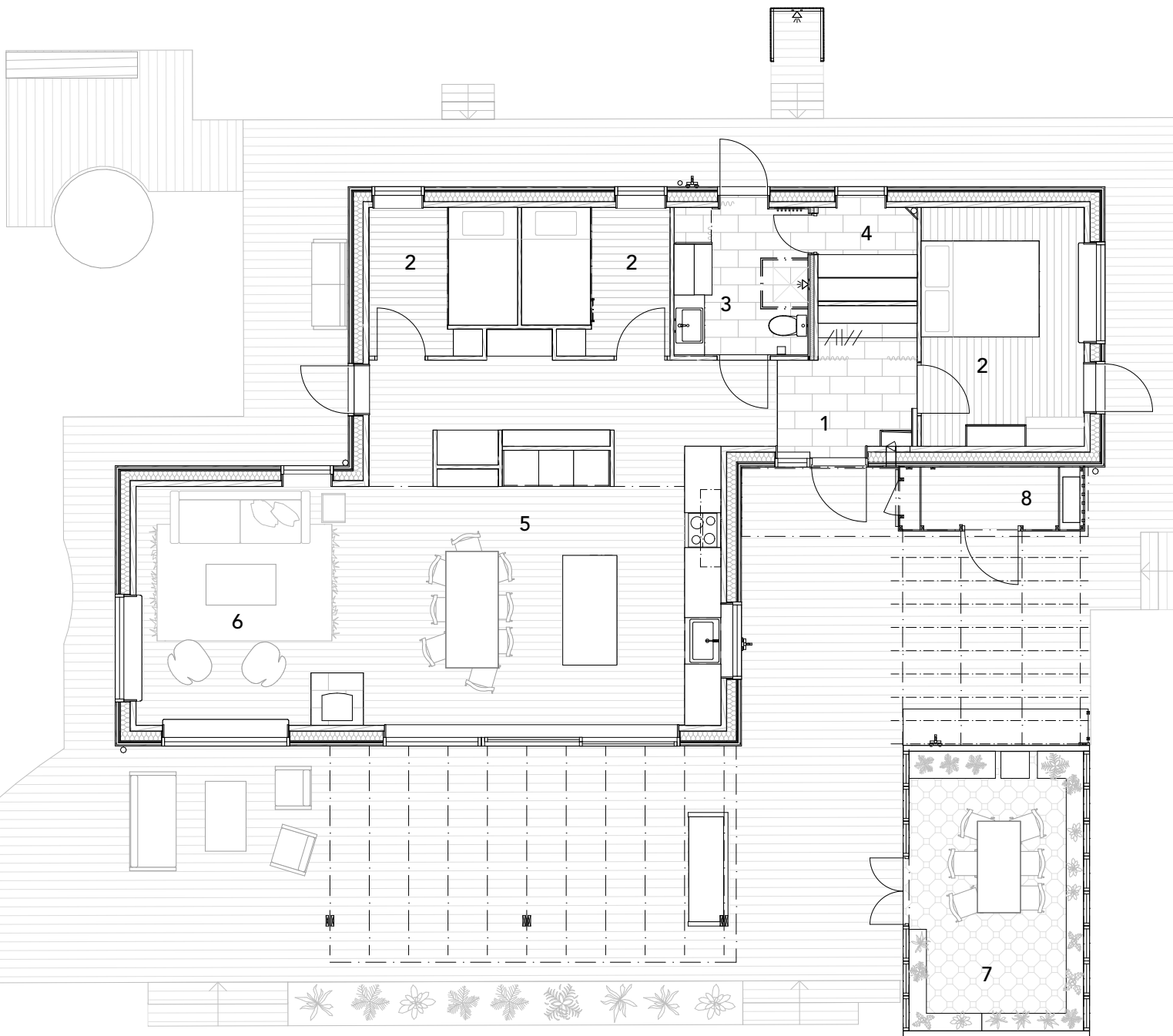



ENTRÉPLAN

VILLA SIV, PLANRITNINGAR  
SKALA 1:100

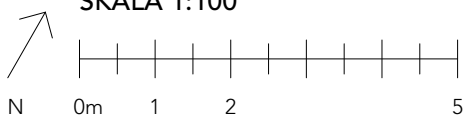

- 1. HALL
- 2. SOVRUM
- 3. BADRUM
- 4. BASTU

- 5. KÖK & MATRUM
- 6. VARDAGSRUM
- 7. VÄXTHUS
- 8. FÖRRÅD

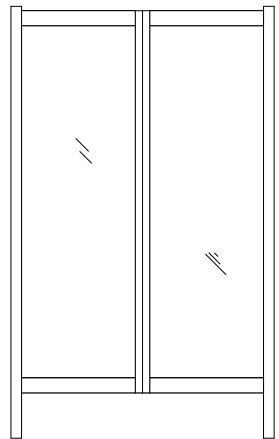
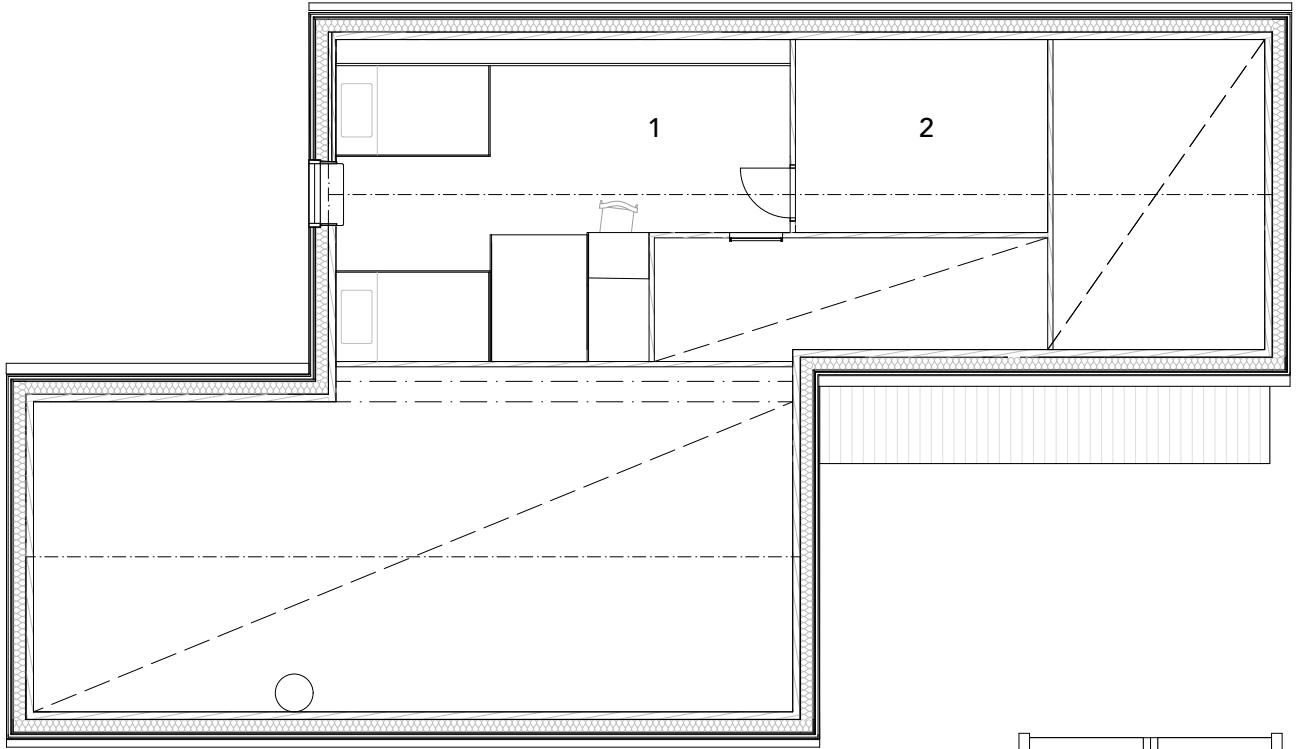

LOFT

VILLA SIV, PLANRITNINGAR  
SKALA 1:100

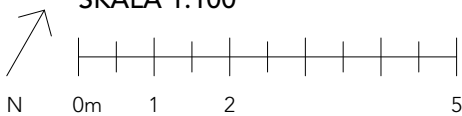

1. LOFT  
2. FRD. & TEKNIK

**WINROTH**  
arkitekter

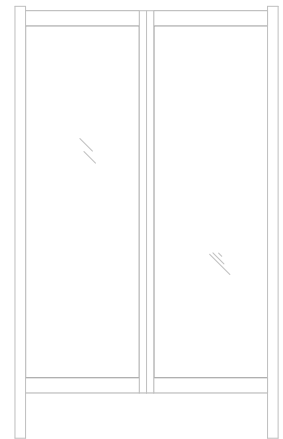
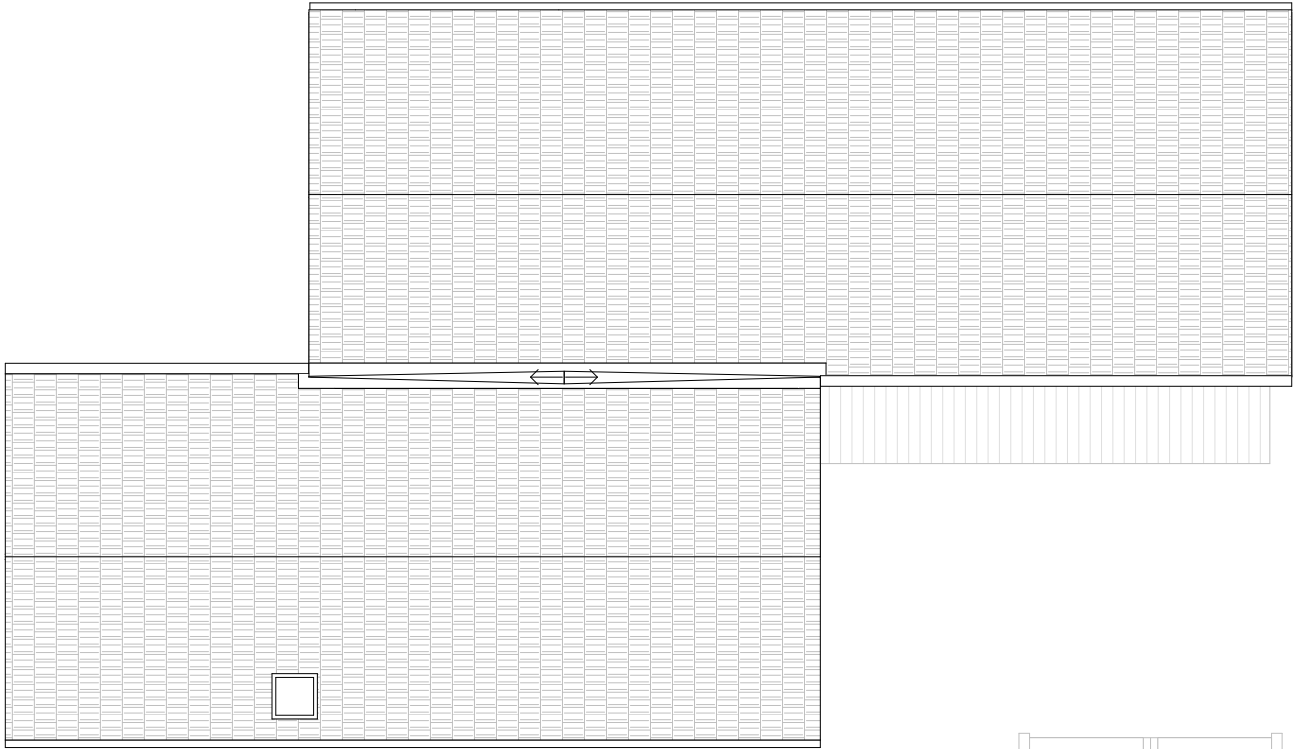

TAKPLAN

VILLA SIV, PLANRITNINGAR  
SKALA 1:100

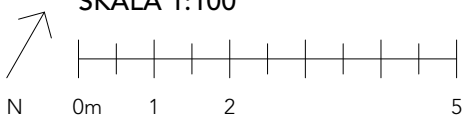

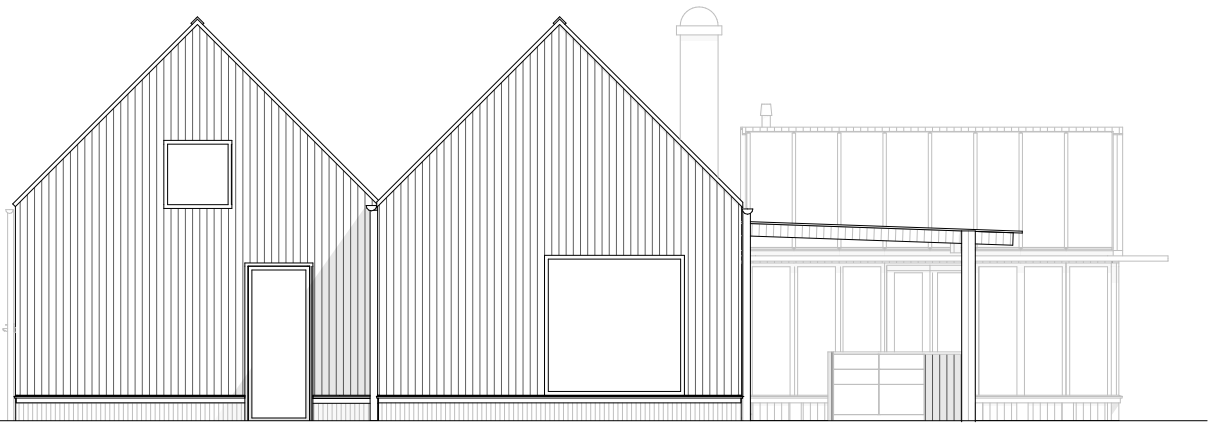

A

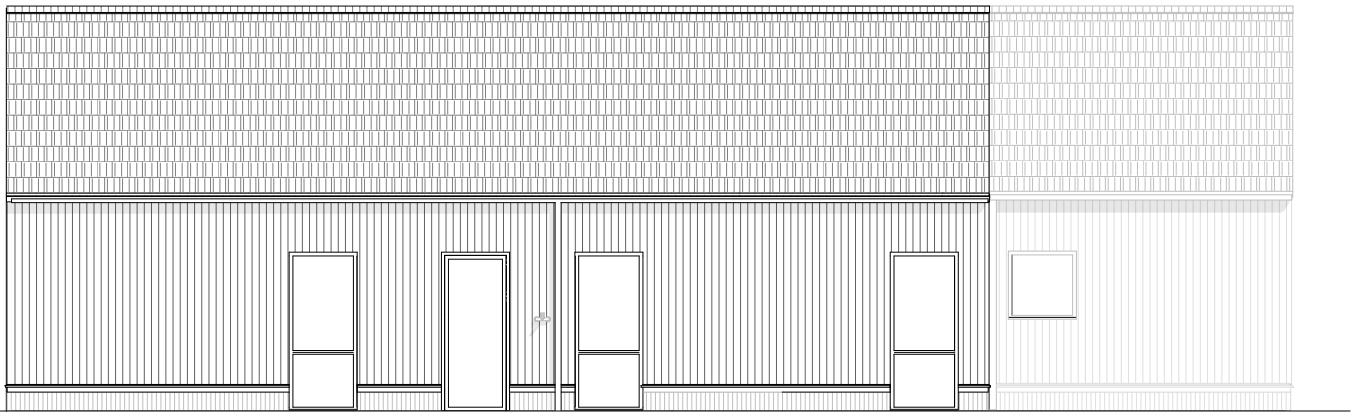

B

VILLA SIV, FASADRITNINGAR  
SKALA 1:100

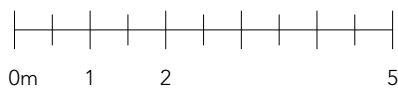

A. FASAD, VÄST  
B. FASAD, NORR

**WINROTH**  
arkitekter

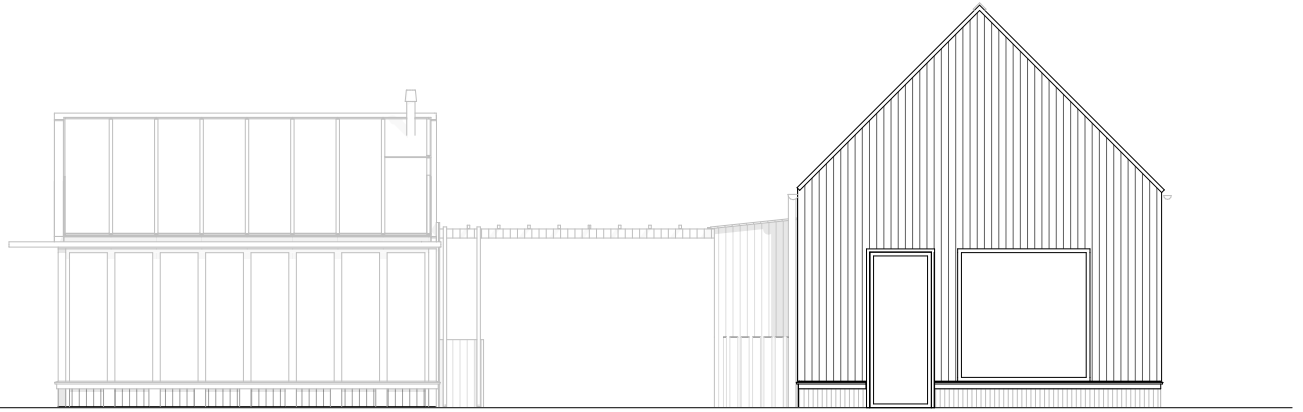

C

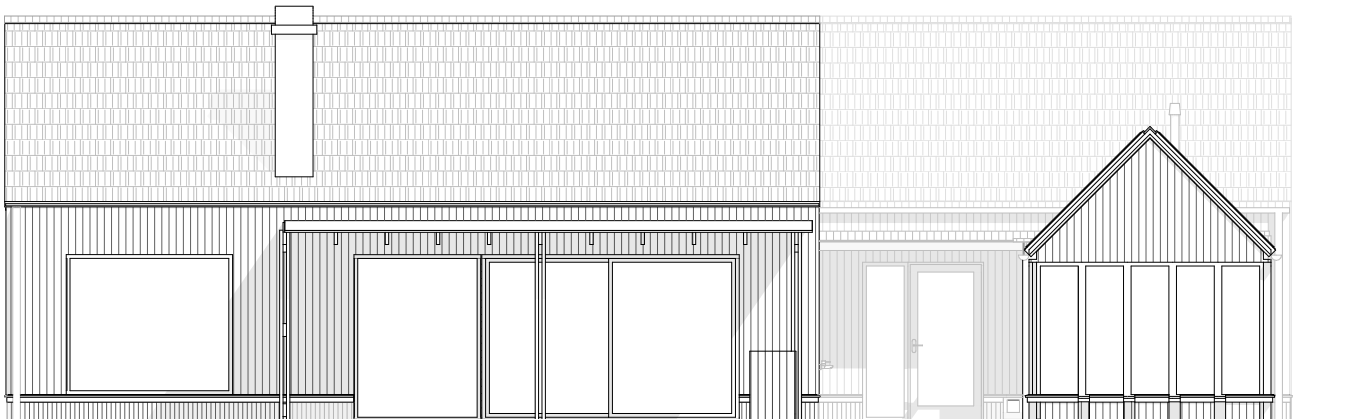

D

VILLA SIV, FASADRITNINGAR  
SKALA 1:100

C. FASAD, ÖST  
D. FASAD, SYD

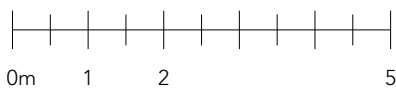

**WINROTH**  
arkitekter

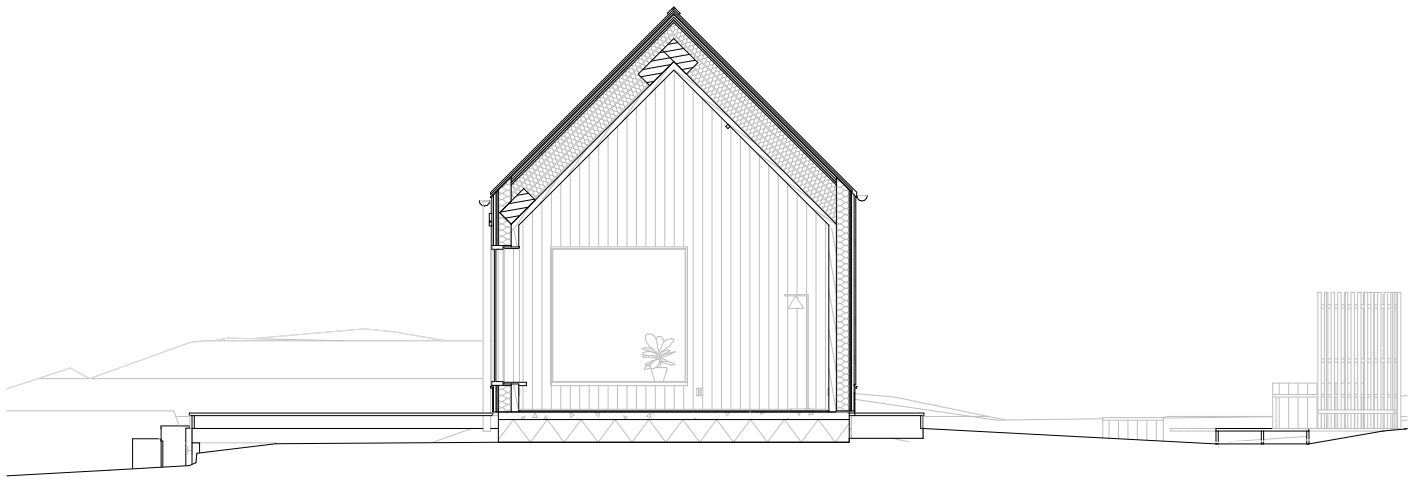

A

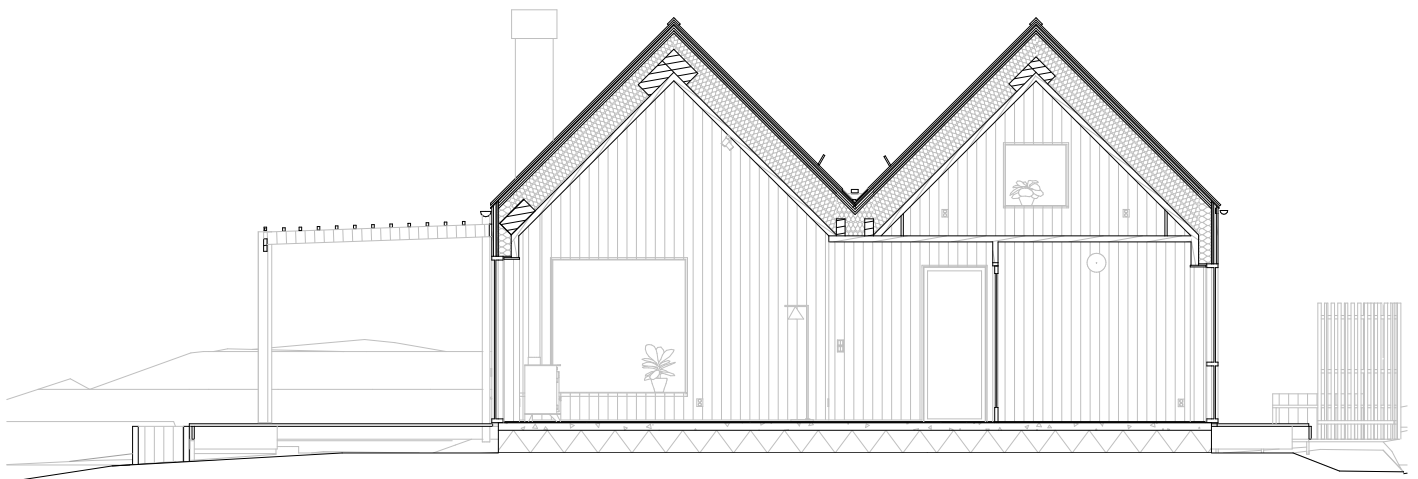

B

VILLA SIV, SEKTIONSRTNINGAR  
SKALA 1:100

A. SEKTION  
B. SEKTION

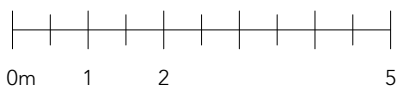

**WINROTH**  
arkitekter

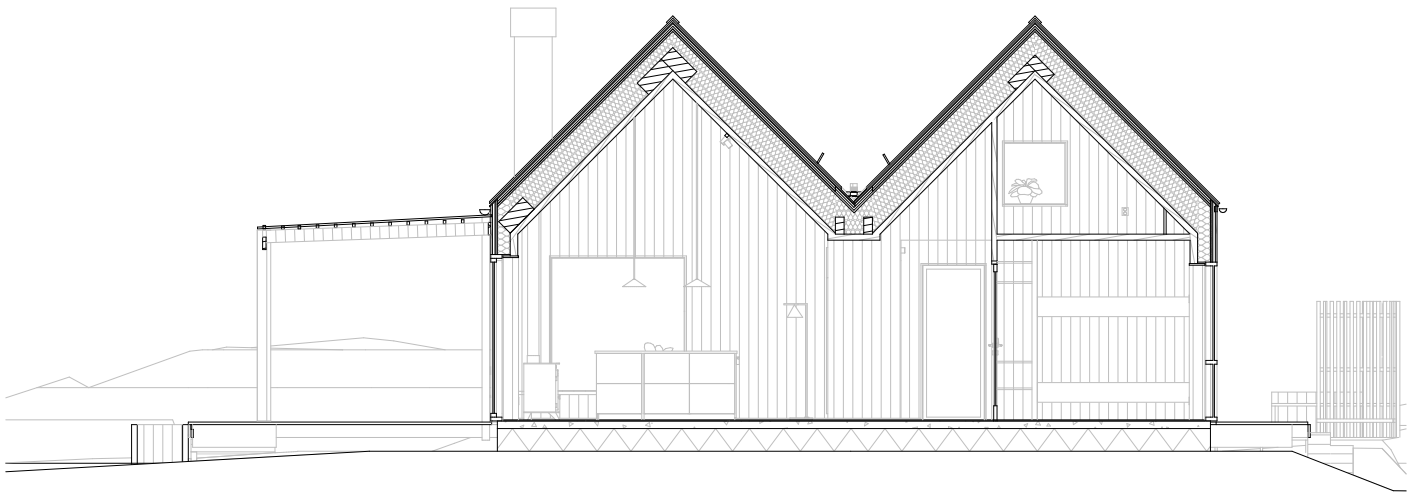

C

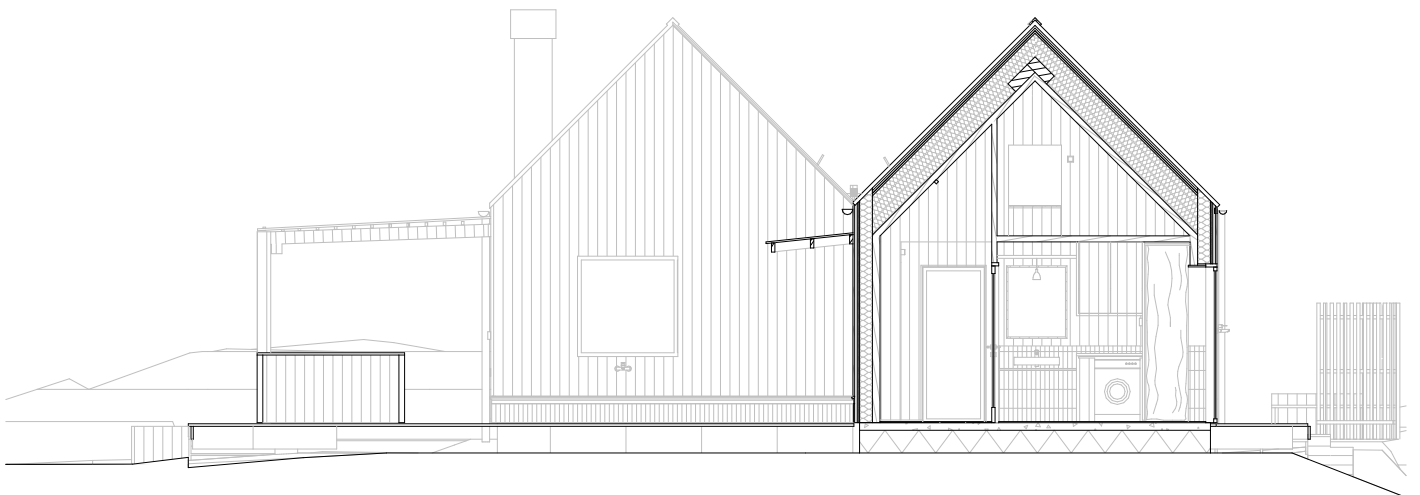

D

VILLA SIV, SEKTIONSRTNINGAR  
SKALA 1:100

C. SEKTION  
D. SEKTION

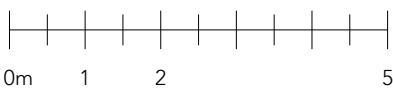

**WINROTH**  
arkitekter

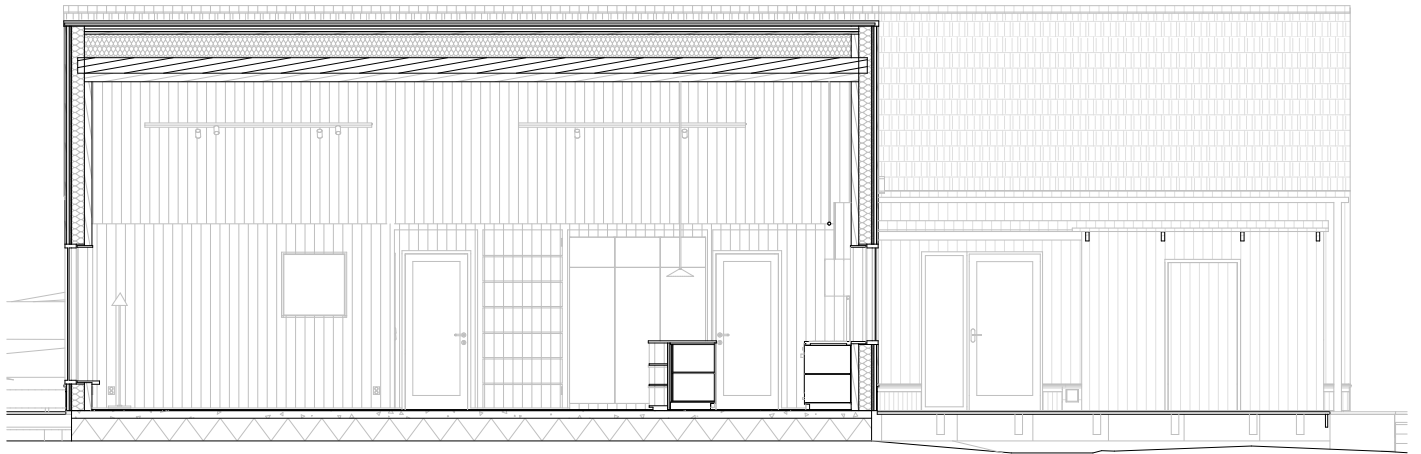

E

VILLA SIV, SEKTIONSRTNINGAR  
SKALA 1:100

E. SEKTION

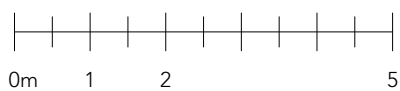

**WINROTH**  
arkitekter

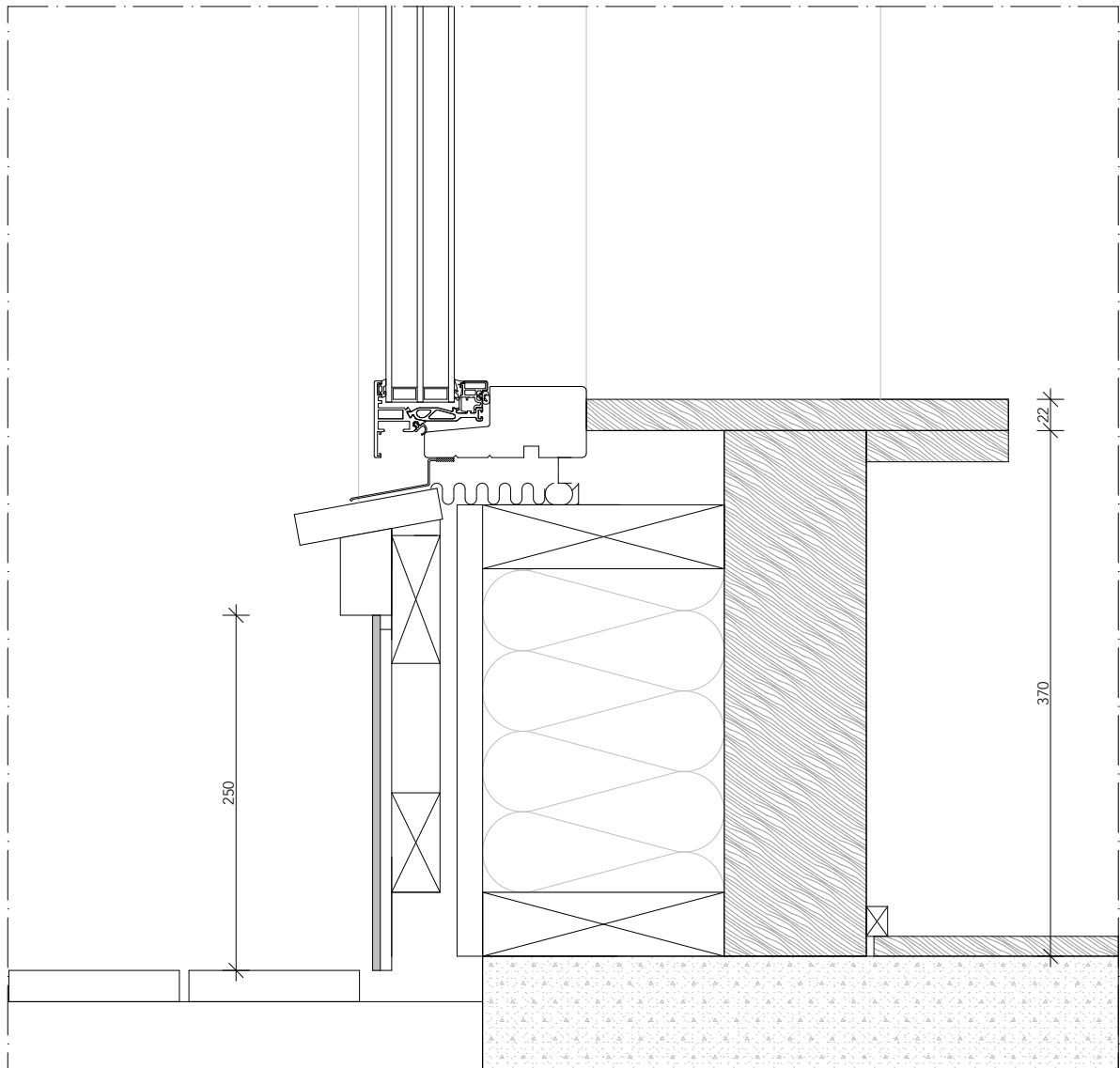

B

VILLA SIV, DETALJER  
SKALA 1:5

B. DETALJ, SOCKEL/FÖNSTER

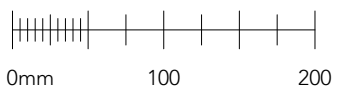

**WINROTH**  
arkitekter

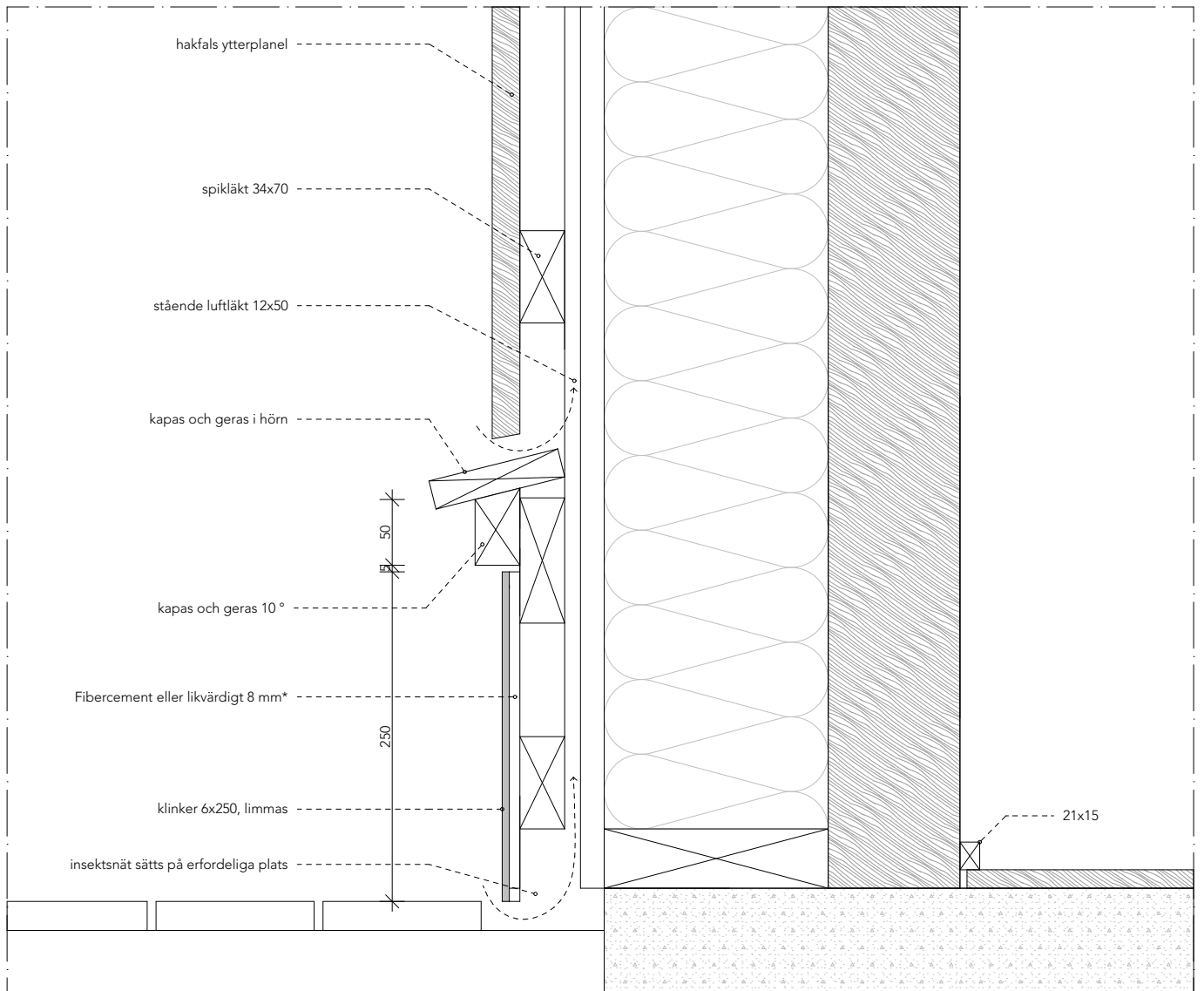

A

VILLA SIV, DETALJER  
SKALA 1:5

A. DETALJ, SOCKEL/TRÄFASAD

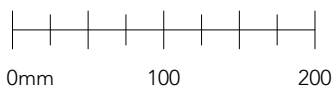

**WINROTH**  
arkitekter

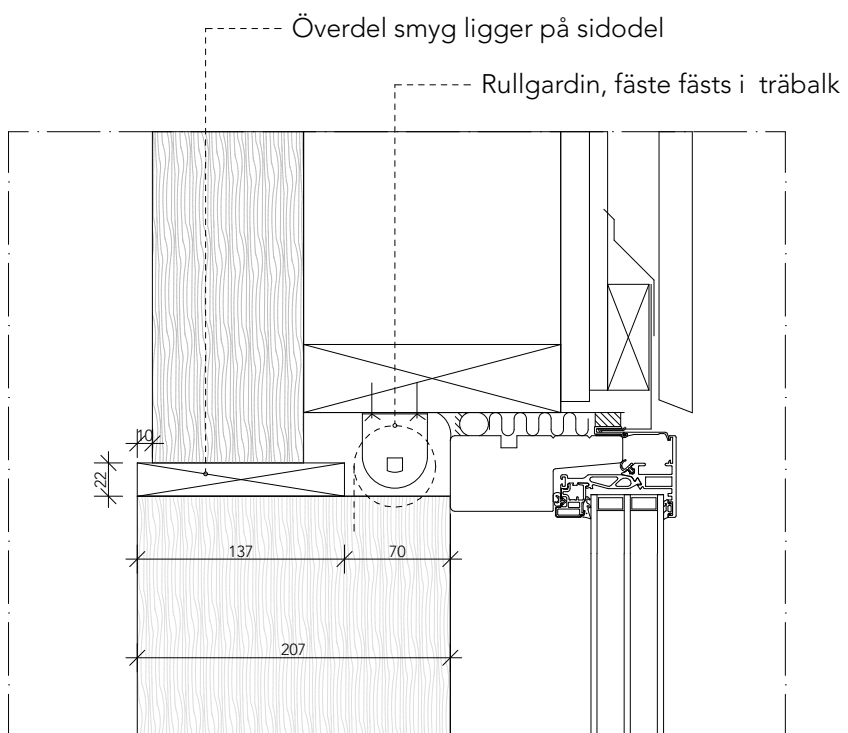

C

VILLA SIV, DETALJER  
SKALA 1:5

C. DETALJ, RULLGARDIN

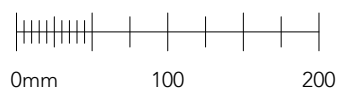

**WINROTH**  
arkitekter